

Reliable dosing of chemicals

Motor-driven diaphragm dosing pumps play an important role in the reliable and accurate dosing of liquids in process cycles. They are appropriate for low-pressure applications and high dosing quantities.

Dosing pumps are used in many branches of industry that work with liquid chemicals - not excluding toxic and highly-aggressive media.

Riding on the crest of the waves

Two sizes of the MEMDOS LB series are available. A large coverage in terms of performance and chemical resistance is available, thanks to the variety of dosing heads, combined with a wide range of dosing head materials.

The performance ranges from 0 - 325 gph. The maximum permitted pressure, depending on the size, is between 58 and 232 psig.

Thanks to the sturdy tappet drive with manual or automatic capacity adjustment, the conveyed media such as acids, lyes, coagulants and flocculants are dosed reliably and precisely.

On request, the MEMDOS LB pumps can also be supplied with a double diaphragm system, therefore avoiding uncontrolled leakage of media if the dosing diaphragm wears out.

Versatile and flexible

The MEMDOS LB can be used when the integration of the pump into external controls or control circuits is required.

For constant dosing without a controller, the power-cord of the MEMDOS LB is directly connected to the terminal box. A variety of three-phase and single-phase motors is available for this purpose.

To adjust the dosing capacity, either the stroke length can be adjusted mechanically/automatically or the speed of the three-phase motor can be regulated by means of a separate variable frequency drive.



In Short

- Capacity range 0 to 325 gph, up to 232 psig
- Minor dependence of the backpressure
- Infinitely variable stroke frequency from 0 to 100%
- Tappet drive with manual and automatic capacity adjustment
- Materials available: PVC, PP, PVDF and stainless steel
- Compact design, low space requirement
- Material consistency for the pumps and accessories
- A variety of three-phase and single-phase motors are available
- Double-diaphragm system (optional)
- ATEX versions for Zones 1 and 2 are available
- Also suitable for variable frequency drive operation

Technical Data

MEMDOS LB			4	4-HP	10	10HP	20	20HP	35	60	80	150
Delivery capacity at maximum backpressure	50 Hz	gph	1.06	2.22	3.70	6.35	5.82	9.52	9.52	16.67	23.81	41.27
	60 Hz		1.3	2.7	4.4	7.6	7.0	11.4	11.4	20	29	50
	ml/stroke		2.7	5.4	2.7	5.4	2.7	5.4	8.6	8.6	21.4	21.4
Max. back pressure		psig	174	232	174	232	174	232	145		72	
Max. stroke frequency	50 Hz	RPM	26		72		120		72	120	72	120
	60 Hz		31.2	31.2	86.4		144		86.4	144	86.4	144
Suction head for non-gassing media		ft _{H₂O}	29						26		23	
Max. inlet pressure		psig	7.3 PSI									
Stroke length		mm	0.3"						0.4"			
Nominal valve width			DN4						DN6		DN10	
Voltage supply			115V (230V optional)									
Motor efficiency			Greater than 90% (energy efficiency class IE4)									
Protection class			IP 55									
Insulation class			F									
Weight (without a motor)	PVC	lb	9.9						13			
	PP		9.9						13			
	PVDF		10.6						16.5			
	Stainless Steel		13.2						24.7			
Max. ambient temperature		°F	PVDF, Stainless Steel 41-113° (104° with PVC parts)									
Max. temperature of the medium		°F	176° (with PVC parts 95°; with PP parts 140°)									

MEMDOS LB			110	160	210	260	310	400	510	760	1010
Delivery capacity at maximum backpressure	50 Hz	gph	30.2	38.1	55.6	69.8	77.8	103.2	133.3	196.8	269.8
	60 Hz		36	46	67	84	93	124	160	236	324
	ml/stroke		21.4		38.1		55.3		170		
Max. back pressure		psig	145				116	87	58		44
Max. stroke frequency	50 Hz	RPM	96	120	96	120	96	120	53	76	107
	60 Hz		115	144	115	144	115	144	64	92	128
Suction head for non-gassing media		feet	23		19		14		3		
Max. inlet pressure		psig	7.3 PSI								
Stroke length		mm	0.4"						0.5"		
Nominal valve width			DN10			DN15			DN25		
Voltage supply			115V (230V optional)								
Motor efficiency			Greater than 90% (energy efficiency class IE4)								
Protection class			IP 55								
Insulation class			F								
Weight (without a motor)	PVC	lb	19.8		21.6		25.4		39		
	PP		19.8		21.6		25.4		30		
	PVDF		21.2		23.6		28.7		35.7		
	Stainless Steel		31.5		38.4		51.1		79.4		
Max. ambient temperature		°F	41-113° (104° with PVC parts)								
Max. temperature of the medium		°F	PVDF, Stainless Steel 176° (with PVC parts 95°; with PP parts 140°)								

Delivery Characteristic Curves

The supply performance graph is valid for 20°C (68°F) for water at 100% stroke frequency. The delivered capacity depends on the medium (density and viscosity) and temperature. Dosing must therefore be calibrated during practical use.

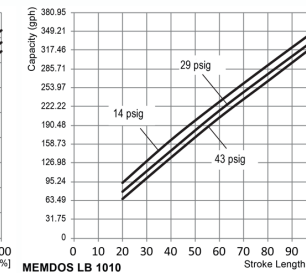
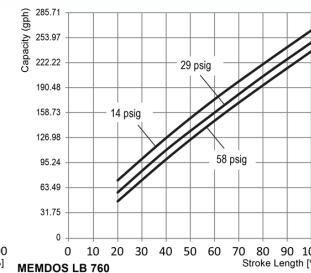
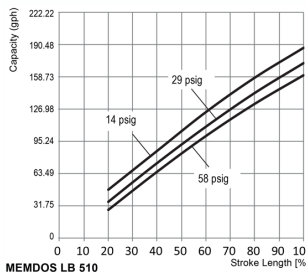
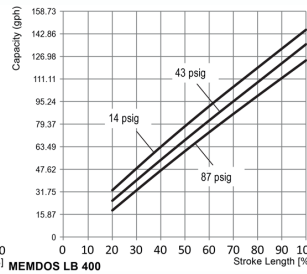
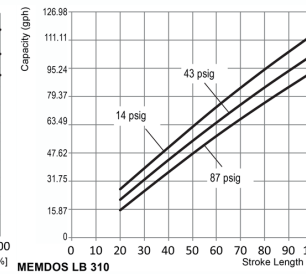
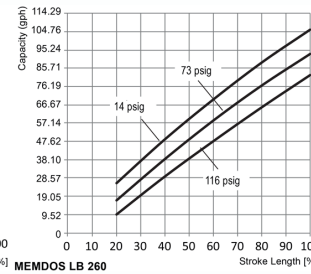
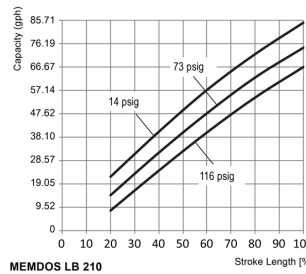
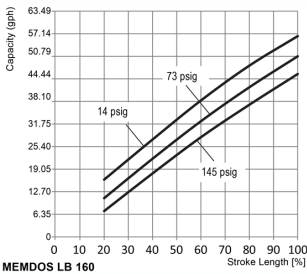
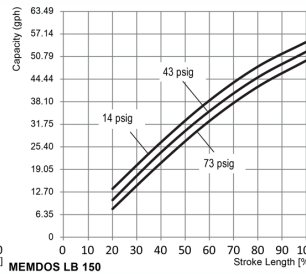
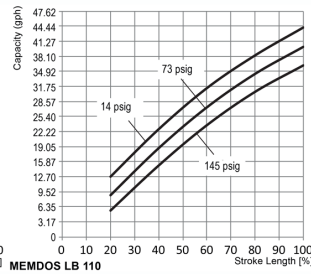
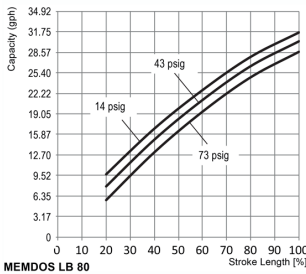
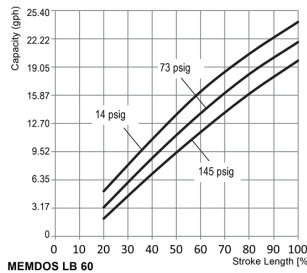
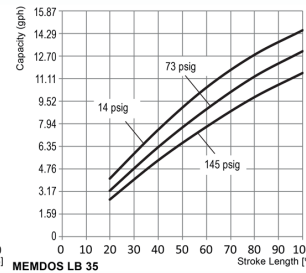
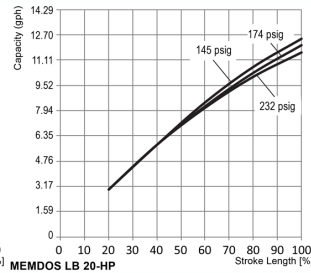
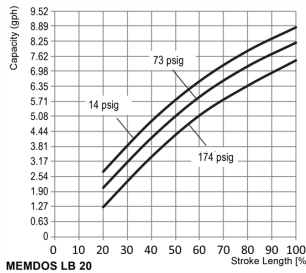
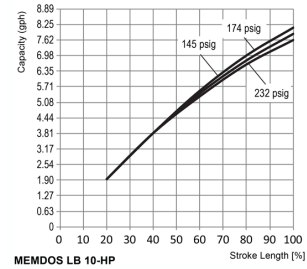
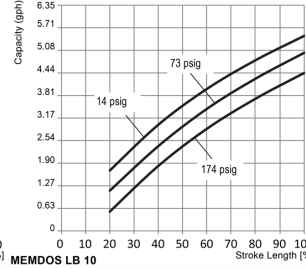
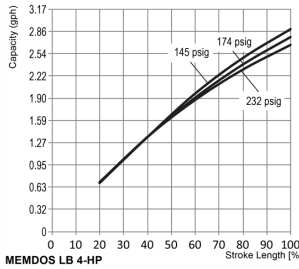
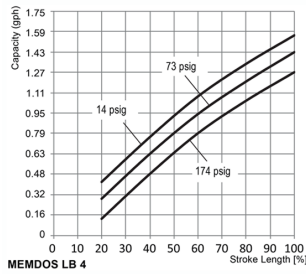

Dimensions

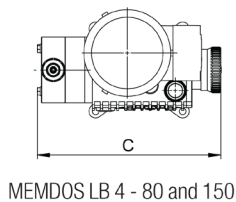
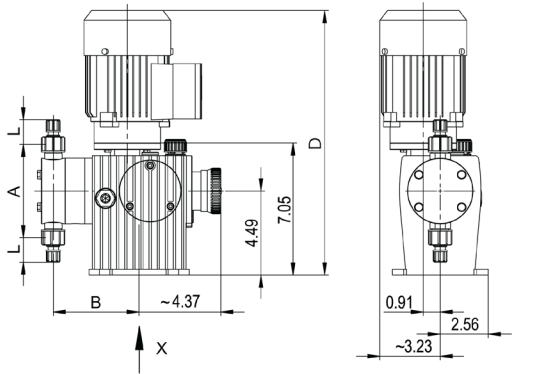

MEMDOS LB 4 - 80 and 150

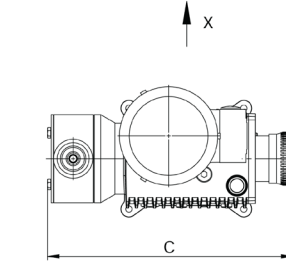
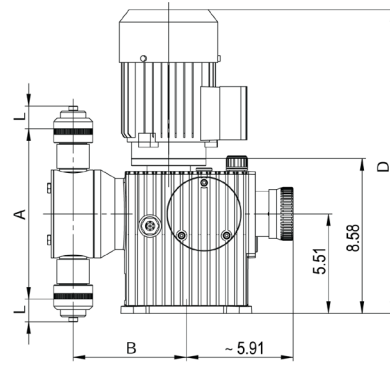
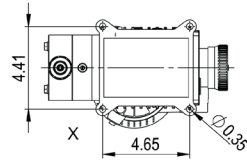

MEMDOS LB 110, 160 - 1010

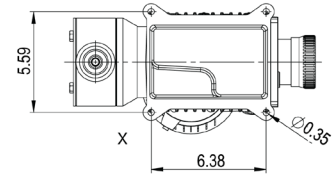

Size	4-20	35-60	80, 150	110, 160	210-260	310-400	510-1010
A	4.96	5.87	9.80	9.45	10.55	12.30	13.86
B	4.57	4.78	5.24	6.30	6.70	6.89	7.28
C	9.96	10.24	11.18	12.80	13.19	13.39	14.37
D (standard motor)	15.31	15.31	15.31	17.20	17.20	17.20	17.72
L	Depends on the connection type and size						

All dimensions in inches

Accessories

Suitable sets of accessories, which consists of a suction line, a pressure line and an injection nozzle, are available for the dosing pumps. Even the best pump can still be improved - namely by the right accessories. To make your dosing pump into an efficient dosing system, we recommend using the following accessories:

- Injection nozzles – to dose the medium in the main line and to prevent it flowing back into the pressure line
- Pressure loading and relief valves – to increase dosing accuracy or to protect the system against excessive pressure

- Pulsation dampener – to dampen supply currents as well as to reduce the flow resistance in long pipelines.
- Priming aids – to significantly ease priming of dosing pumps with low supply volumes per stroke, for large suction heights, for highly viscous dosing media or for initial priming or when priming after the system has been laying idle
- Suction pressure regulator – to prevent medium flow when the dosing pump is not running or to prevent a vacuum being formed in the event of a pipe burst

For further accessories for your dosing pump, please refer to our dosing pump brochure.